

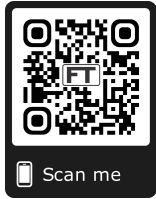

ACTUATORS & CONTROLS



Pneumatic Actuators



C Series Pneumatic Rack & Pinion Rotary Actuators Spring Return & Double Acting

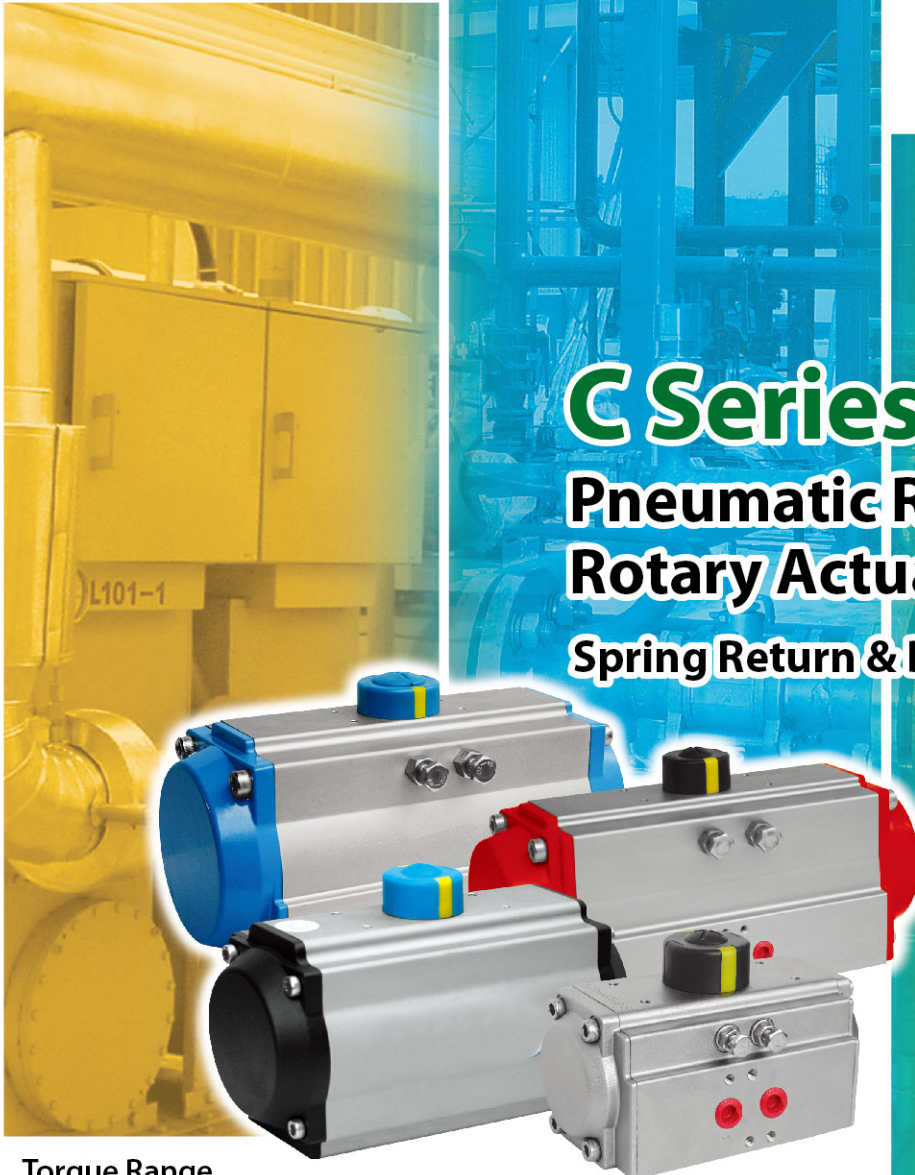

Torque Range
50 thru 28500 in-lbs
Independent Travel Stop Adjustment
Range of 5° for the 90° Rotation
Actuators are available with different color end caps

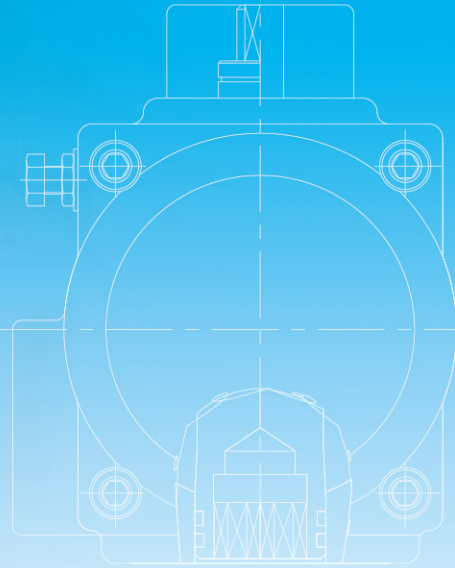
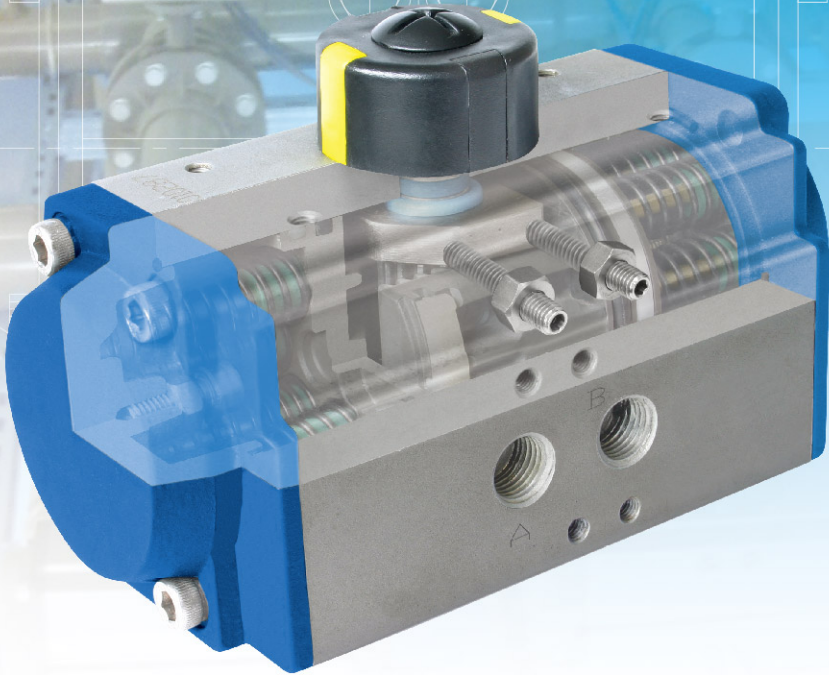

Torque Range at 80 Psig Air Pressure:

Double Acting: 115 - 28,500 lbf-in

Spring Return: 50 - 16,500 lbf-in

Cycle Life: up to 1 million cycles

VALVE - ILLINOIS, USA - WWW.ACCURATEVALVE.COM - PH: +1 (708) 588 - 1433



- Extruded Aluminum Body with standard hard anodized finish and polished internal surfaces
- Die Cast Aluminum End Caps powder polyester paint, PTFE or nickel plated.
- Position Indicator with NAMUR slot for ease of accessory mounting
- High Precision Nickel Alloy Steel Blow-out Proof Pinion provides corrosion protection and fully confirms to ISO 5211 and NAMUR standards.
- Dual Opposed Rack Pistons with low friction bearings and guides for high performance, long cycle life and fast response. Pistons can be easily inverted for reversing rotation.
- Linear Torque Output from 0° through 90° stroke.
- Independent Travel Stop Adjustments of ±5° in both open and closed positions for precise valve alignment.

- High Performance Pre-loaded Spring Cartridges allow for greater safety and longer spring life. Double acting units can be easily converted to spring return by adding the appropriate quantity of cartridges. Different torque requirements can also be easily achieved by changing the quantity of springs.
- NAMUR Solenoid Mounting Design permits direct mounting of solenoid valves.
- Stainless Steel 304 Fasteners as standard
- High Quality O-rings provides trouble-free operation for a wide range of temperature applications.
- Optional Corrosion Protection available for body and end caps.

Double Acting Type

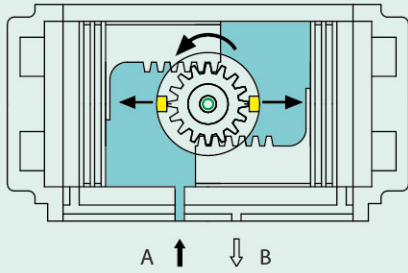

By supplying air to Port A, pressure is applied to the center chamber and forces the dual pistons outward. Linear piston force is transferred via gear racks to the pinion gear, causing the pinion to turn counterclockwise while the air is being exhausted from Port B.

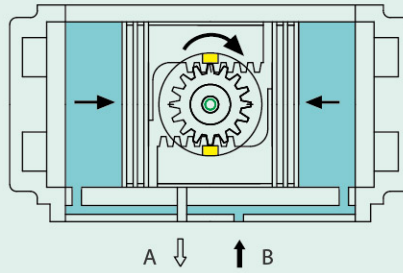

By supplying air to Port B, pressure is applied to the outside chamber and drives the dual pistons inward. This action causes the pinion to turn clockwise while the air is being exhausted from Port A.

Spring Return Type

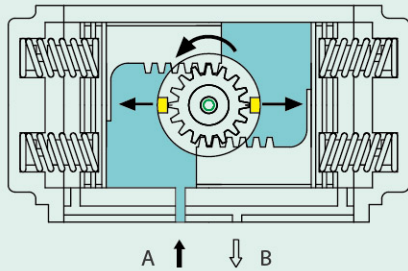

By supplying air to Port A, pressure is applied to the center chamber, forces the dual pistons outward and compresses the springs in the outside chambers and produce counterclockwise rotation.

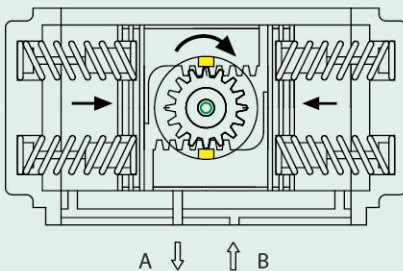

Upon loss of air pressure, the stored energy in the compressed springs forces the pistons inwards producing a rotary motion with exhaust air exiting at Port A. This "fail safe" position is held by spring force until air pressure reapplied to Port A.

Installation of Springs for Spring Return Actuator

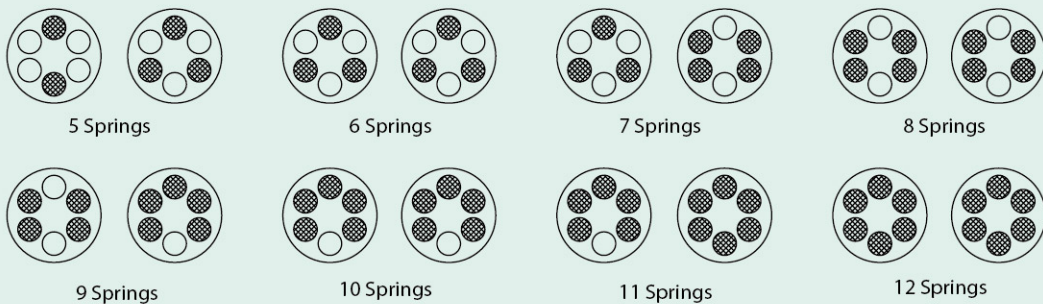

Even spring set is recommended for high cycle application. It is also feasible to insert an odd number of springs per side. If by doing so, to provide a more efficient actuator sizing can be achieved.

Flexible Design

Convert DA to SR and reverse, simply by adding or removing springs.

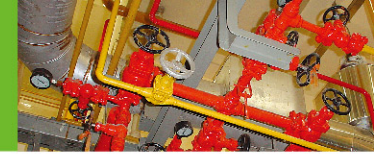

Epoxy Coated Pre-loaded Springs

Exploded View

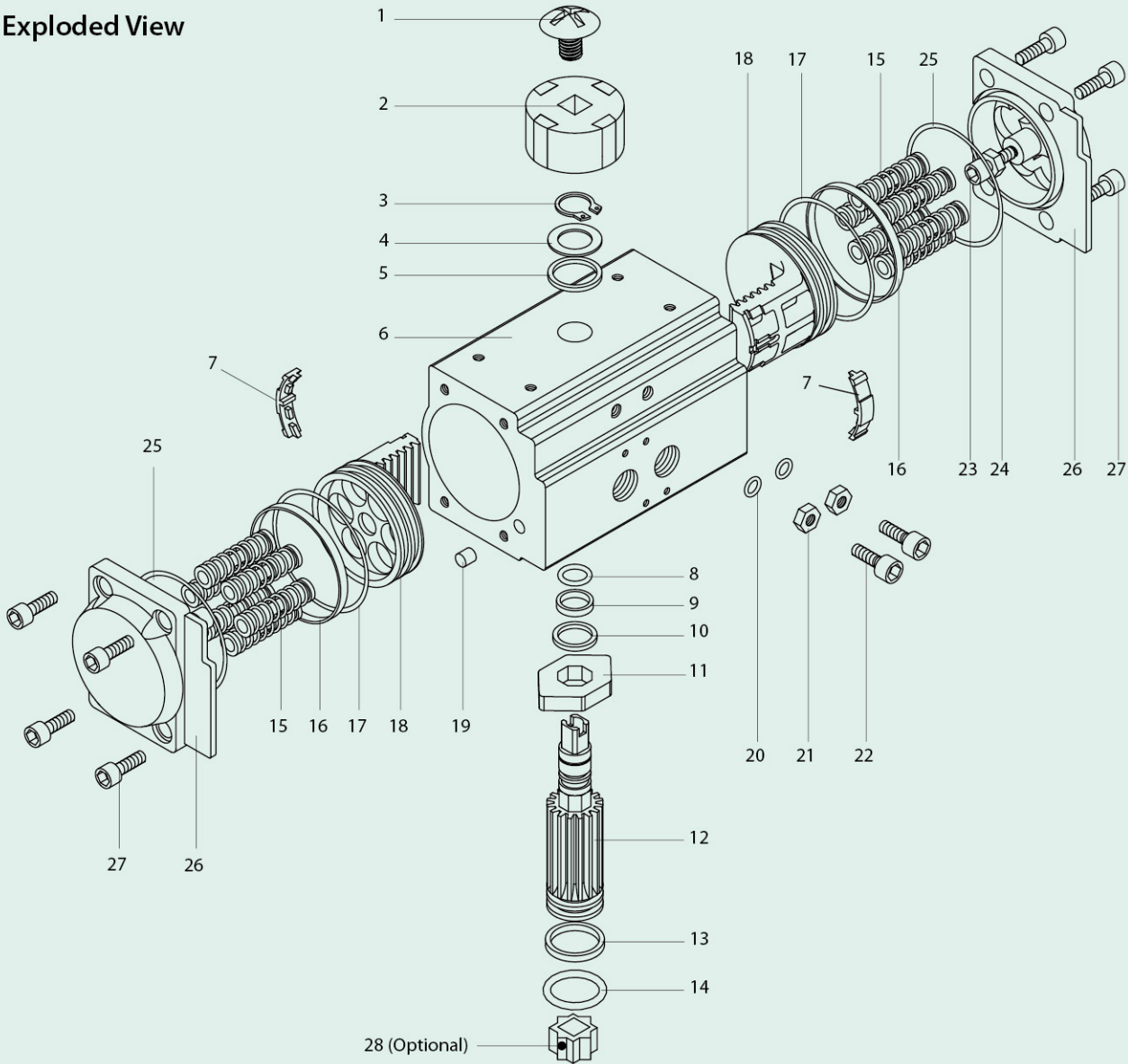

No.	Part Description	Qty.	Material
1	Indicator Cap Screw	1	Plastic / Stainless Steel
2	Position Indicator	1	Plastic (ABS)
3	Pinion Snap Ring	1	Stainless Steel 300 Series
4	Thrust Washer	1	Stainless Steel 300 Series
5	Thrust Bearing	1	Polyoxymethylene (Delrin)
6	Body	1	Extruded Aluminum Alloy
7	Piston Guide	2	Polyoxymethylene (Delrin)
8	O-ring (Pinion Top)	1	NBR / Buna
9	Bearing (Pinion Top)	1	Polyoxymethylene (Delrin)
10	Inside Washer	1	Polyoxymethylene (Delrin)
11	Cam	1	Alloy Steel*
12	Pinion (Drive Shaft)	1	S.S. 300 Series / Nickel Plated Alloy*
13	Bearing (Pinion Bottom)	1	Polyoxymethylene (Delrin)
14	O-ring (Pinion Bottom)	1	NBR / Buna

No.	Description	Qty.	Material
15	Spring (Cartridge)	0~12	High Alloy Spring Steel
16	Bearing (Piston)	2	Polyoxymethylene (Delrin)
17	O-ring (Piston)	2	NBR / Buna
18	Piston	2	Die-Casting Aluminum
19	Plug	2	NBR / Buna
20	O-ring (Adjust Screw)	2	NBR / Buna
21	Stop Nut (Adjust Screw)	2	Stainless Steel 300 Series
22	Adjust Screw	2	Stainless Steel 300 Series
23	Stop Screw	2	Stainless Steel 300 Series
24	Nut (Stop Screw)	2	Stainless Steel 300 Series
25	O-ring (End Cap)	2	NBR / Buna
26	End Cap	2	Die-Casting Aluminum
27	End Cap Screw	8	Stainless Steel 300 Series
28	Shaft Adapter	1	Sintered Metal

* Stainless steel shaft available on request.

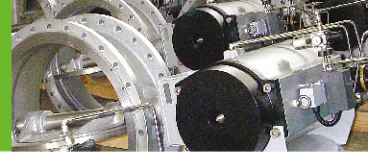

DATASHEET PROVIDED COURTESY OF ACCURATE VALVE - ILLINOIS, USA - WWW.ACCURATEVALVE.COM - PH: +1 (708) 588 - 1433

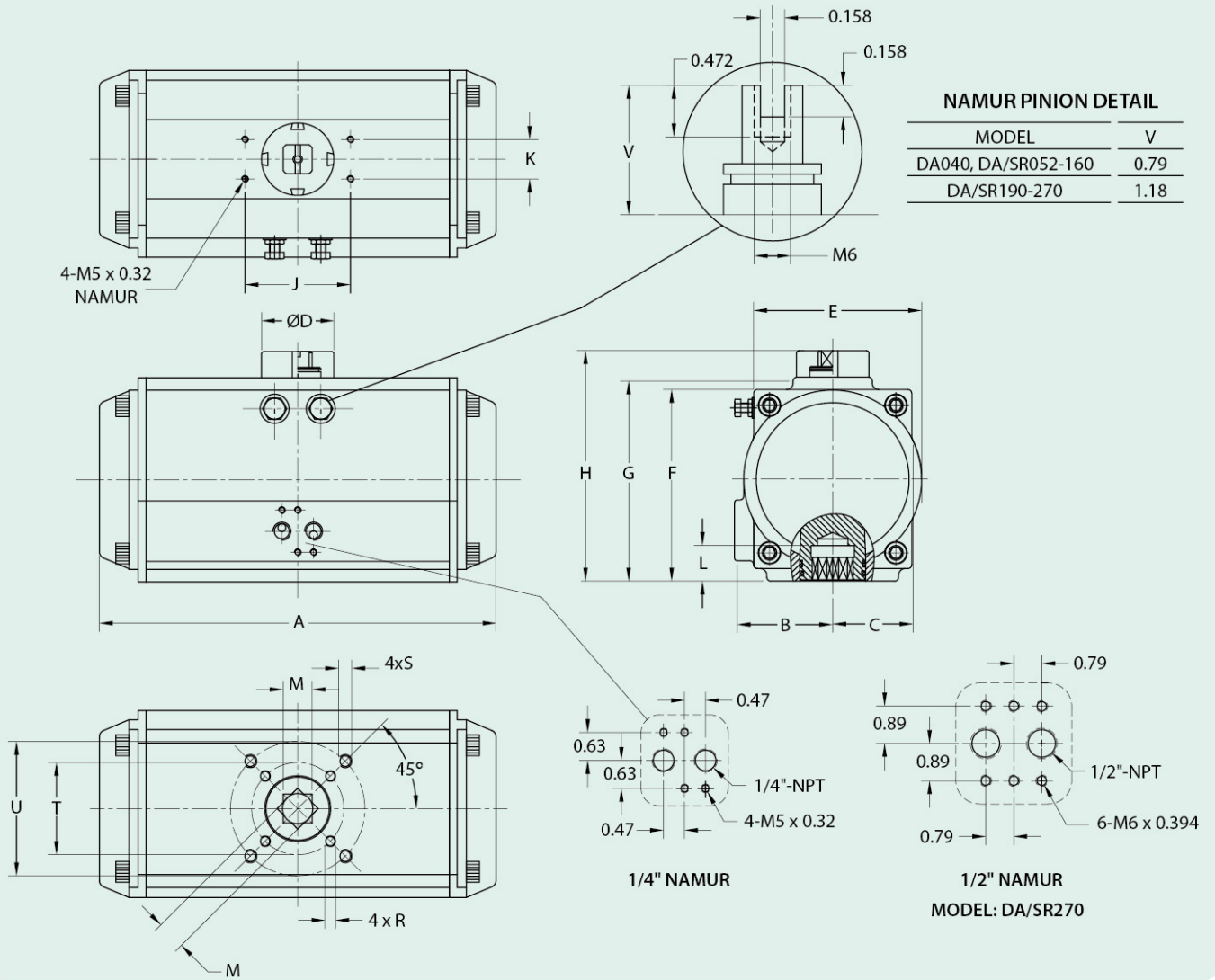

Unit: inch

Model	A	B	C	D	E	F	G	H	J	K	L	M	R	S	T	U
DA040	4.81	1.13	1.44	1.58	2.05	2.36		3.15	3.15	1.18	0.55	0.43	M5x8	M6x10	F03/1.417	F05/1.969
DA/SR052	5.79	1.18	1.63	1.58	2.56	2.58	2.83	3.62	3.15	1.18	0.55	0.43	M5x8	M6x10	F03/1.417	F05/1.969
DA/SR063	6.61	1.42	1.85	1.58	2.83	3.19	3.44	4.23	3.15	1.18	0.71	0.55	M6x10	M8x13	F05/1.969	F07/2.756
DA/SR075	7.24	1.65	2.09	1.58	3.19	3.70	3.92	4.70	3.15	1.18	0.71	0.55	M6x10	M8x13	F05/1.969	F07/2.756
DA/SR083	8.03	1.81	2.24	1.58	3.62	3.88	4.28	5.07	3.15	1.18	0.83	0.67	M6x10	M8x13	F05/1.969	F07/2.756
DA/SR092	10.31	1.97	2.30	1.58	3.86	4.37	4.60	5.39	3.15	1.18	0.83	0.67	M6x10	M8x13	F05/1.969	F07/2.756
DA/SR105	10.55	2.26	2.52	1.58	4.31	4.82	5.24	6.02	3.15	1.18	1.02	0.87	M8x13	M10x16	F07/2.756	F10/4.016
DA/SR125	11.85	2.66	2.93	2.17	5.02	5.73	6.10	6.89	3.15	1.18	1.02	0.87	M8x13	M10x16	F07/2.756	F10/4.016
DA/SR140	15.35	2.95	3.03	2.17	5.41	6.33	6.75	7.54	3.15	1.18	1.22	1.06	M10x16	M12x20	F10/4.016	F12/4.921
DA/SR160	18.03	3.43	3.43	2.17	6.22	7.24	7.76	8.54	3.15	1.18	1.22	1.06	M10x16	M12x20	F10/4.016	F12/4.921
DA/SR190	20.79	4.06	4.06	3.15	7.44	8.50	9.06	10.24	5.12	1.18	1.57	1.42		M16x25		F14/5.512
DA/SR210	20.94	4.45	4.45	3.15	8.27	9.27	10.04	11.22	5.12	1.18	1.57	1.42		M16x25		F14/5.512
DA/SR240	23.70	5.12	5.12	3.15	9.65	10.39	11.38	12.56	5.12	1.18	1.97	1.81		M20x25		F16/6.496
DA/SR270	28.42	5.79	5.79	3.15	10.75	11.77	12.83	14.01	5.12	1.18	1.97	1.81		M20x25		F16/6.496

Consult factory for DA032 information.

Spring Return Actuator Output Torque (lbf-in)

		Output Air to Spring														Spring Return Output	
Air Pressure (PSI)		40		50		60		70		80		90		100			
Actuator Type	Spring No.	0° Start	90° End	0° Start	90° End	0° Start	90° End	0° Start	90° End	0° Start	90° End	0° Start	90° End	0° Start	90° End	90° Start	0° End
SR052	5	55	37	77	58											55	38
	6	48	24	70	46	94	78									66	45
	7	39	13	61	34	90	67	120	89							77	52
	8			53	20	84	55	113	78	140	114					87	60
	9			44	8	76	44	105	67	133	104	160	132			98	67
	10					68	33	98	57	126	94	153	122			109	75
	11					60	21	91	46	119	84	146	113	172	140	120	82
	12						83	36	112	74	139	95	166	130	131	90	
SR063	5	111	75	153	116	204	137									92	61
	6	98	55	138	95	191	152	242	205							111	72
	7	84	35	127	73	179	133	229	187							129	85
	8			111	52	167	114	218	169	267	220	315	269			148	97
	9					154	95	206	151	255	203	304	253			166	109
	10					132	75	195	133	244	186	293	236	341	286	185	121
	11							184	115	234	169	283	220	330	270	203	133
	12						171	97	222	152	271	204	320	254	222	145	
SR075	5	141	103	197	158	270	235									128	93
	6	121	74	176	128	251	208	321	280							154	112
	7	101	47	155	99	232	182	303	256							179	131
	8			133	69	211	155	284	231	352	301	418	369			205	149
	9					192	129	266	206	335	278	402	347			231	168
	10					174	102	246	181	318	254	386	324	451	391	256	187
	11							231	157	301	231	369	301	435	369	282	205
	12						213	132	284	207	353	278	419	346	308	224	
SR083	5	227	157	317	244	428	364									204	140
	6	196	112	285	196	400	321	508	434							244	168
	7	166	67	252	151	371	279	481	395							285	196
	8			221	103	342	237	454	355	560	466	663	572			326	224
	9					313	192	426	316	534	429	638	536			367	252
	10					284	152	400	276	508	391	613	500	715	605	407	280
	11							373	237	483	353	588	464	691	570	448	308
	12						345	198	456	316	563	428	667	536	489	336	
SR092	5	322	214	450	338	612	511									304	207
	6	277	148	403	269	569	449	725	612							365	248
	7	231	80	355	197	526	385	685	553							426	289
	8			319	128	484	323	646	495	799	655	947	808			487	331
	9					441	260	606	436	761	599	911	755			548	372
	10					399	197	566	377	723	543	874	700	1022	853	608	413
	11							525	318	685	487	837	647	986	801	669	454
	12						486	260	647	432	800	593	950	749	730	496	
SR105	5	497	325	687	508	921	760									436	280
	6	435	229	622	407	862	670	1088	908							523	336
	7	374	133	559	308	805	580	1035	824							610	392
	8			494	208	747	490	980	740	1203	974	1419	1198			697	448
	9					689	400	927	656	1152	894	1370	1122			784	504
	10					631	306	872	569	1100	811	1320	1041	1535	1264	871	560
	11							818	487	1048	733	1270	966	1486	1191	958	616
	12						764	406	997	656	1221	892	1439	1119	1045	672	



New KOMPACT 4

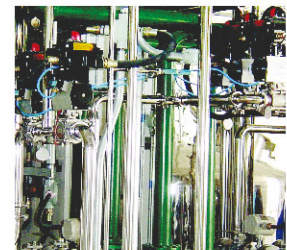
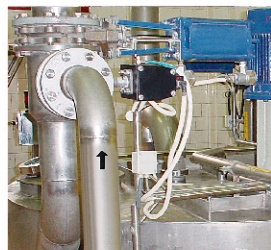



Spring Return Actuator Output Torque (lbf-in)

		Output Air to Spring														Spring Return output			
Air Pressure (PSI)		40		50		60		70		80		90		100					
Actuator Type	Spring No.	0°	90°	0°	90°	0°	90°	0°	90°	0°	90°	0°	90°	0°	90°	0°	90°		
		Start	End	Start	End	Start	End	Start	End	Start	End	Start	End	Start	End	Start	End		
SR125	5	712	453	1000	729	1358	1115										698	462	
	6	610	305	893	574	1263	976	1608	1340								832	555	
	7	509	148	787	410	1167	828	1519	1202								971	647	
	8			681	255	1071	689	1429	1072	1770	1429	2100	1772				1110	740	
	9					976	541	1340	934	1685	1298	2018	1645				1249	832	
	10					880	402	1251	804	1600	1174	1936	1526	2264	1865	1387	925		
	11							1161	666	1514	1043	1854	1399	2184	1742	1530	1017		
	12						1072	536	1429	919	1772	1280	2105	1626	1665	1110			
SR140	5	1246	823	1737	1296	2346	1948										1143	759	
	6	1082	573	1566	1035	2192	1713	2778	2331								1370	908	
	7	916	324	1392	773	2035	1478	2631	2112								1598	1059	
	8			1218	512	1878	1244	2485	1892	3063	2498	3624	3080				1826	1211	
	9					1713	1009	2331	1673	2916	2290	3483	2879				2054	1370	
	10					1557	765	2185	1446	2777	2073	3348	2670	3906	3247	2283	1522		
	11							2039	1226	2638	1864	3214	2468	3776	3051	2510	1673		
	12						1892	1007	2498	1655	3080	2267	3645	2855	2741	1824			
SR160	5	1877	1212	2640	1943	3592	2966										1844	1236	
	6	1609	805	2359	1518	3340	2583	4256	3549								2212	1483	
	7	1332	398	2069	1093	3079	2200	4012	3192								2581	1730	
	8			1789	667	2826	1818	3777	2022	4680	3782	5556	4691				2949	1977	
	9					2566	1435	3533	2477	4448	3442	5332	4363				3321	2225	
	10					2313	1052	3297	2120	4223	3102	5116	4034	5986	4935	3691	2472		
	11							3062	1771	3999	2769	4900	3714	5776	4624	4056	2719		
	12						2818	1413	3767	2429	4676	3386	5559	4305	4422	2966			
SR190	5	3228	2164	4457	3345	5957	4957										2737	1774	
	6	2839	1563	4051	2717	5592	4392	7041	5921								3287	2127	
	7	2451	962	3645	2088	5227	3827	6700	5393								3834	2480	
	8			3239	1460	4861	3261	6359	4865	7789	6366	9180	7808				4380	2833	
	9					4496	2696	6018	4337	7464	5863	8867	7323				4927	3186	
	10					4131	2131	5677	3809	7139	5360	8554	6838	9936	8269	5473	3540		
	11							5336	3281	6814	4858	8240	6354	9632	7798	6020	3893		
	12						4995	2753	6490	4355	7927	5869	9327	7327	6566	4246			
SR210	5	3801	2774	5327	4254	7227	6262										3363	2430	
	6	3265	2035	4767	3481	6723	5566	8552	7472								4036	2917	
	7	2728	1295	4206	2707	6218	4870	8081	6822								4708	3405	
	8			3645	1934	5714	4174	7610	6172	9413	8044	11164	9844				5381	3893	
	9					5209	3479	7139	5523	8965	7426	10731	9247				6053	4380	
	10					4705	2783	6668	4873	8516	6807	10299	8651	12038	10436	6726	4868		
	11							6197	4223	8068	6188	9866	8054	11617	9856	7399	5356		
	12						5726	3574	7619	5569	9434	7457	11197	9276	8071	5843			
SR240	5	5373	3977	7571	6111	10332	9018										4902	3632	
	6	4578	2895	6739	4979	9584	8001	12239	10761								5885	4355	
	7	3773	1822	5898	3858	8827	6992	11533	9819								6861	5087	
	8			5066	2727	8079	5975	10834	8869	13451	11579	15989	14184				7844	5810	
	9					7323	4957	10128	7919	12778	10674	15340	13312				8828	6541	
	10					6575	3948	9429	6976	12113	9777	14699	12446	17220	1503	9803	7264		
	11							8731	6026	11448	8872	14057	11574	16596	14183	10787	7987		
	12						8024	5076	10775	7967	13408	10701	15966	13335	11771	8719			
SR270	5	8786	6576	12163	9852	16289	14210										6961	4952	
	6	7695	5050	11022	8257	15263	12775	19256	16934								8349	5944	
	7	6612	3514	9891	6652	14245	11332	18306	15585								9744	6928	
	8			8750	5057	13219	9897	17348	14245	21286	18332	25109					11132	7920	
	9					12193	8453	16389	12897	20374	17048	24229	21023				12527	8912	
	10					11167	7018	15431	11557	19461	15771	23349	19792	27156	23699	13914	9904		
	11							14473	10209	18548	14487	22469	18554	26300	22496	15310	10896		
	12						13523	8869	17643	13211	21597	17324	25452	21300	16697	11880			

• Large sizes available see extended range series.

DATASHEET PROVIDED COURTESY OF ACCURATE VALVE - ILLINOIS, USA - WWW.ACCURATEVALVE.COM - PH: +1 (708) 588 - 1433

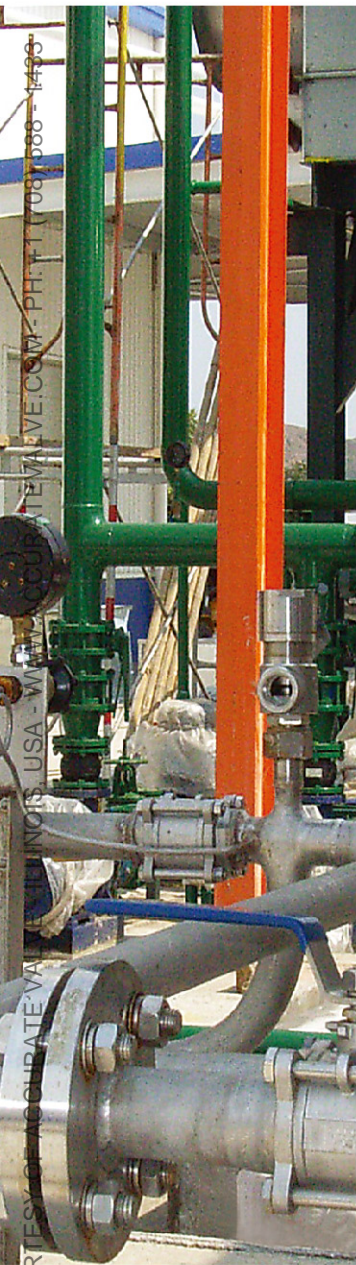

Double Acting Actuator Output Torque (lbf-in)

MODEL	Air Pressure (Psig)								
	40	50	60	70	80	90	100	110	120
DA040	55	71	85	100	115	129	142	157	171
DA052	97	122	146	171	195	219	244	268	292
DA063	178	223	267	313	356	401	446	490	535
DA075	245	306	368	430	490	551	613	674	735
DA083	383	476	574	671	766	861	957	1053	1149
DA092	551	689	827	967	1103	1240	1378	1516	1654
DA105	808	1009	1211	1416	1615	1817	2019	2221	2423
DA125	1225	1532	1833	2149	2450	2757	3063	3369	3676
DA140	2088	2611	3133	3662	4177	4699	5221	5743	6265
DA160	3249	4061	4873	5697	6497	7309	8122	8934	9746
DA190	5198	6497	7797	9115	10396	11695	12995	14294	15594
DA210	6497	8122	9746	11394	12995	14619	16243	17868	19492
DA240	9398	11753	14097	16480	18796	21151	23495	25850	28194
DA270	14282	17856	21430	25046	28565	32139	35712	39286	42859

Weight (lbs)

MODEL	040	052	063	075	083	092	105	125	140	160	190	210	240	270
DA	2	3	4	6	7	10	13	19	25	36	70	76	106	163
SR		3	4	6	7	12	14	22	29	44	78	85	135	216

Maximum Air Consumption (cu. inches) Per Stroke (Piston Displacement)

Model Action	052	063	075	083	092	105	125	140	160	190	210	240	270
CCW	7.3	12.9	18.3	26.2	39.1	58.0	97.6	152.5	225.7	359.9	457.5	671.2	1037.5
CW	9.7	14.1	20.7	28.7	44.6	53.7	85.4	134.2	195.2	329.4	457.5	549.3	854.4

Actuator Cycle Speed (sec.)

Action	Model	052	063	075	083	092	105	125	140	160	190	210	240	270
CCW	DA	0.3	0.5	0.5	0.5	0.6	0.8	0.9	1.2	1.5	2.2	2.8	3.5	3.5
	SR	0.4	0.6	0.6	0.6	0.7	1.0	1.1	1.4	2.0	2.5	3.5	4.2	4.5
CW	DA	0.4	0.6	0.6	0.7	0.8	1.0	1.2	1.5	1.8	2.5	3.5	4.2	4.5
	SR	0.4	0.8	1.0	1.0	1.2	1.2	1.5	1.8	2.5	3.0	4.0	5.0	6.0

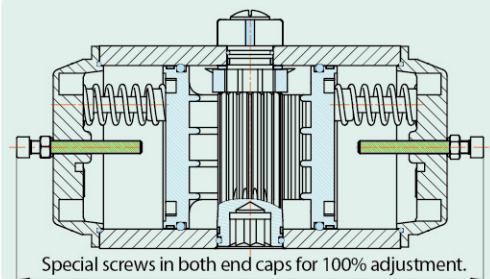
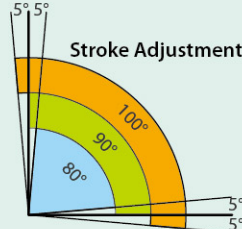
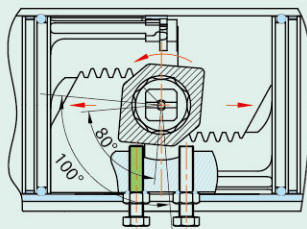
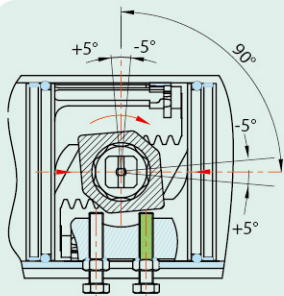

- Bi-Directional Travel Stops
- Valves are manufactured with acceptable travel tolerance. Air-Cons standard two way rotation travel stops, provide a minimum rotation of -5 degrees to +5 degrees.
- Optional limiting 100% travel stops.

- Assures positive sealing, correct port alignment and longer valve life.
- Quarter turn valves such as butterflies, metal seated, multi-port and other specific rotation valves require actuators that are capable of compensating for the accumulation of tolerances that lead to valve malfunction and damage.

DATASHEET PROVIDED COURTESY OF ACCURATE VALVES USA - WWW.ACCURATEVALVES.COM - PH: 717-081-0888 - FAX: 717-081-1499



Operating Conditions

- Operating Media:**
 Dry and lubricated air, or non-corrosive gas.
 The maximum particle diameter must be less than 30 μm .
 Optional units shall be able to operate with other media such as hydraulic oil or purified water.
 Consult factory for further information.
- Air Supply Pressure:**
 The minimum supply pressure is 35 psig.
 The maximum supply pressure is 150 psig.
- Operating Temperature:**
 Standard (NBR O-ring): -4 °F to 175 °F.
 Low Temperature (LNBR O-ring): -30 °F to 175 °F.
 High Temperature (Viton O-ring): 5 °F to 300 °F.
- Stroke Adjustment:**
 Stops allow adjustment range of $\pm 5^\circ$ for the rotation at 0° and 90° positions.
- Application:**
 All types of ball, butterfly and plug valves both indoor and outdoor.
 Our Air-Con actuators are also ideal for use in the retrofit of damper drives.

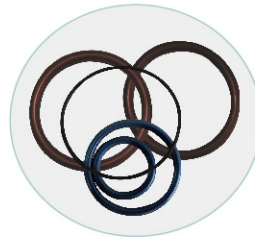

Soft Pack

Actuator repair kits available in many different materials

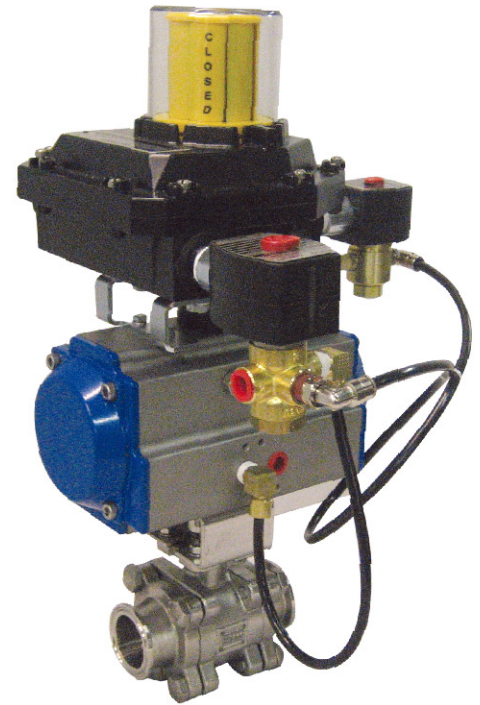

Interface Specification



Drive and Flange to ISO 5211 configuration for easy direct mount onto a valve or connection with standardized mounting hardware.

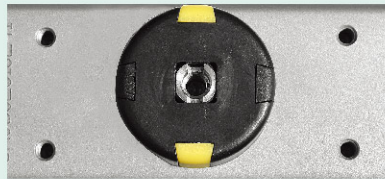

The NAMUR Drive Pinion and NAMUR top mounting connection for direct installation of accessories such as Limit Switch and Positioner.



Air supply connection is designed in accordance with NAMUR Standard to install solenoid valve.

Body and End Finish



Electroless Nickel Plating Infused Housing Provide an effective corrosion resistant Application

Different colors powder polyester painted body and ends available.



Double Acting Actuators

As shown in the figure, the output torque of double acting actuator is constant in both clockwise and counterclockwise rotation. Actuator can be sized by using steps as follow:

- Obtain the published maximum valve torque
- Add recommended safety factor to the published torque to get the required operating torque. The suggested safety factor for Double Acting Actuator in normal working conditions is at least 15%.
- Refer to the table of Double Acting Actuator Output Torque above, use the Air Supply Pressure to find the torque that is greater than the required operating torque.
- Check the table Model number to determine the appropriate actuator.

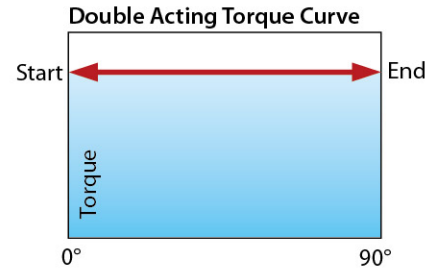

Example:

- A published highest seating/unseating torque for a 8" high performance butterfly is 2600 lbf-in; the hydrodynamic torque for 2 psi pressure drop is 500 lbf-in. The maximum valve torque is $2600 + 500 = 3100$ lbf-in
- The required operating torque equals to $3100 + 3100 \times 20\% = 3720$ lbf-in
- Known Air Supply Pressure 80 psig, the first actuator torque that exceeds to the required torque is 4177 lbf-in
- From the table, the selected double acting actuator model is C-DA140.

Spring Return Actuators

The output torque of spring return actuator is obtained by two operations - Air Stroke and Spring Stroke. Each stroke produces two different values in the operation end position "Start" or "End" shown in the right figures. The four values are used for sizing the actuator.

- Obtain the published maximum valve torque in working conditions.
- Add recommended safety factor (margin) to the published torque to get the required operating torque. The suggested safety factor for Spring Return Actuator in normal working conditions is 10%.
- Refer to the table of Spring Return Actuator Output Torque above, use the Air Supply Pressure to locate the Air End torque greater than the required operating torque.
- Move to table for Spring Return Output column. Check to see if the Spring End torque exceeds the required torque.
- Read left cross the table to locate the Spring Numbers and Actuator Model to determine the appropriate actuator size and spring numbers

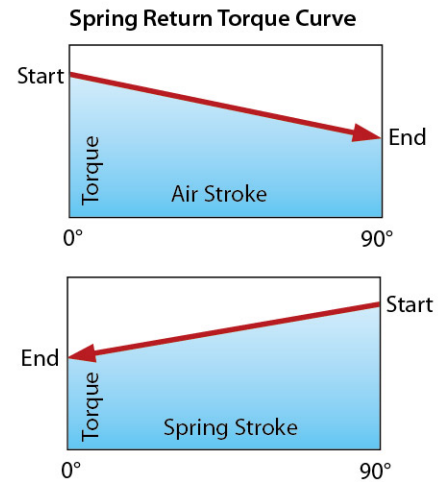

Example:

- Given a maximum published torque for a 2" flanged valve in full differential pressure is 400 lbf-in
- The required operating torque is $400 + 400 \times 10\% = 440$ lbf-in
- Given Air Supply Pressure is 80 psig, find the Spring Return actuator both Air End torque (487 lbf-in) and Spring End torque (454 lbs-in) values exceeding the required torque (440 lbf-in)
- Cross the table to the left, the selected Spring Return actuator model is C-SR92-11.



How To Order/Actuator Identification Code

Series	Type	Model	Spring Qty.	Seals	Option	Color Code	Coating
C	SR - Spring Return DA - Double Acting	52	5 6 7 8 9 10 11 12	N - NBR L - LNBR V - Viton	FO - Fail Open 180 - 180° Operation X - Special	(E-) End Color - 1) Black - 2) Blue - 3) Gray - R) Red	T - TFE P - Polyester X - Special
		63					
	75						
	83						
	92						
	105						
	125						
	140						
	160						
	190						
	210						
	240						
270							

Body can also be colored to your standard. C/F
For Spring Return type, 12 springs are provided as standard.

Quality Assurance

- All actuators are manufactured in a registered ISO 9001-2000 facility.
- All actuators are CE certified.
- All actuators are 100% inspected and factory tested.
- Each actuator is marked with a unique serial number for full traceability.

Flo-Tite can also provide valve automation accessories, including Limit Switches, Positioners, Solenoid Valves, and Mounting Hardware.

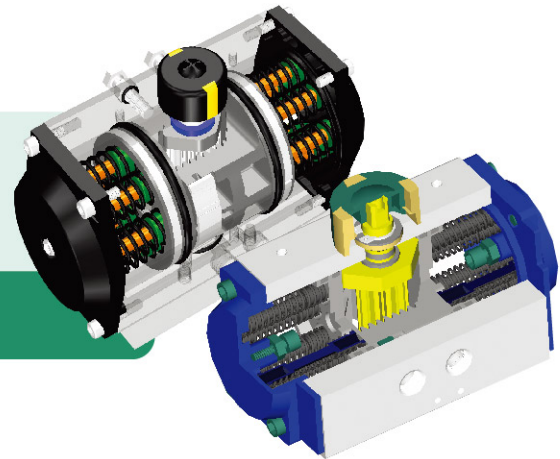

Additional Actuator Series

A Series Actuator

Stainless Steel Body, Pinion, Pistons and Fasteners
Model A-DA/SR46-160
Torque:
up to 6500 lbf-in for DA
3600 lbf-in for SR

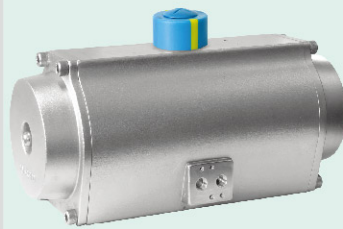

B Series Actuator

Aluminum Body, Ends, Wide Range of Selection
Model B-DA32-400, SR45-400
Torque:
up to 78000 lbf-in for DA
63700 lbf-in for SR

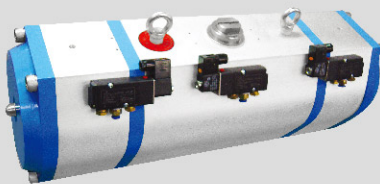
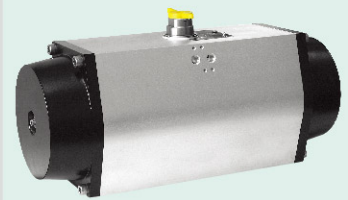

Special Stroke and 3-Position Actuators
idea for multi port 3 & 4 way valves

XB Series Actuator



Torque:
up to 1565201 lbf-in for DA
691756 lbf-in for SR

Air-Con is one of the world's largest suppliers of rack and pinion design pneumatic actuators with torque range from 50 through 1,560,000 lbf-in.

AIR CON Automation Accessories



Flo-Tite Offers A Complete Line of Ball and Butterfly Valves of All Types.



DATASHEET PROVIDED COURTESY OF ACCURATE VALVE - ILLINOIS, USA - WWW.ACCURATEVALVE.COM - PH: +1 (708) 588 - 1433



P.O. Box 1293
Lumberton, NC 28359

Website: www.airconinc.com

Aircon, Inc.
Division of Flo-Tite, Inc.
4815 West 5th Street
Lumberton, NC 28358

Tel: (910) 738-7664

Fax: (910) 739-1733

E-mail: info@airconinc.com

This brochure is general in nature and manufacturer reserves the right to alter dimensions, materials or to make design improvements